

AC Phase Cut ZigBee Dimmer

70110004-A



Important: Read All Instructions Prior to Installation

Function introduction

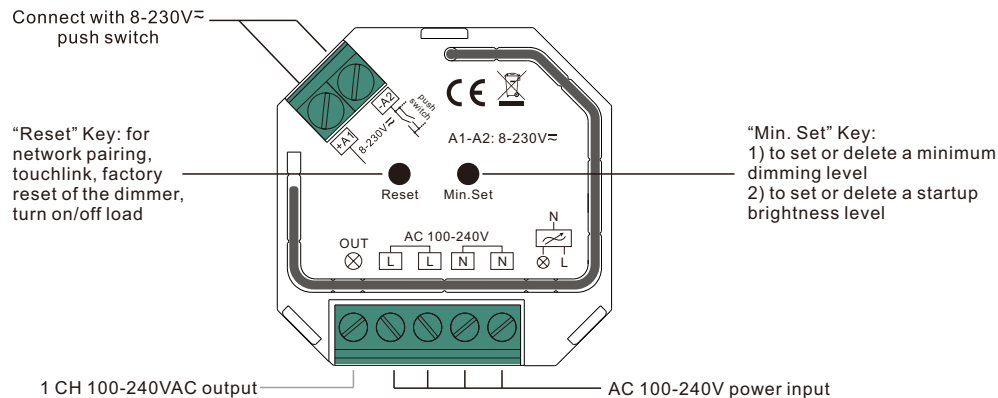

- ZigBee AC phase cut dimmer based on latest ZigBee 3.0 protocol
- 100-240VAC Wide Input and Output Voltage
- Supports resistive loads and capacitive loads
- 1 Channel Output, Up to 400W
- Input and Output with Screw Terminals, Safe and Reliable
- Both leading edge version and trailing edge version are available for choosing, default factory setting is trailing edge
- Enables to control ON/OFF and light intensity of connected triac dimmable led light or led driver
- ZigBee end device that supports Touchlink commissioning
- Can directly pair to a compatible ZigBee remote via Touchlink without coordinator
- Supports self-forming zigbee network without coordinator and add other devices to the network
- Supports find and bind mode to bind a ZigBee remote
- Supports zigbee green power and can bind max. 20 zigbee green power remotes
- Compatible with universal ZigBee gateway products
- Can be controlled by universal 8-230V input single wire push switch
- Mini Size, Easy to be Installed into a standard 86*86mm wall box
- Radio Frequency : 2.4GHz
- Waterproof grade: IP20

Safety & Warnings

- DO NOT install with power applied to device.
- DO NOT expose the device to moisture.

ZigBee Clusters the device supports are as follows:

Input Clusters

- 0x0000: Basic
- 0x0003: Identify
- 0x0004: Groups
- 0x0005: Scenes
- 0x0006: On/off
- 0x0008: Level Control
- 0x0b05: Diagnostics

Output Clusters

- 0x0019: OTA

Operation

1. Do wiring according to connection diagram correctly.

2. This ZigBee device is a wireless receiver that communicates with a variety of ZigBee compatible systems. This receiver receives and is controlled by wireless radio signals from the compatible ZigBee system.

3. Zigbee Network Pairing through Coordinator or Hub (Added to a Zigbee Network)

Step 1: Remove the device from previous zigbee network if it has already been added to, otherwise pairing will fail. Please refer to the part "**Factory Reset Manually**".

Step 2: From your ZigBee Controller or hub interface, choose to add lighting device and enter Pairing mode as instructed by the controller.

Step 4: Connected light will blink 5 times and then stay solid on, then the device will appear in your controller's menu and can be controlled through controller or hub interface.

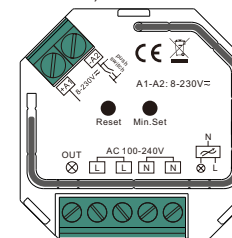

Step 3: power on the device, it will be set into network pairing mode (connected light flashes twice slowly), the network pairing mode will last until the device is added to a zigbee network.

Product Data

| Input Voltage | Output Voltage | Output Current | Size(LxWxH) |
|---------------|----------------|----------------|----------------|
| 100-240VAC | 100-240VAC | 1.8A max | 45.5x45x20.3mm |

| Compatible Load Types | | | |
|-----------------------|---|----------------------------|---|
| Load Symbol | Load Type | Maximum Load | Remarks |
| | Dimmable LED lamps | 200W @ 230V 100W @ 120V | Due to variety of LED lamp designs, maximum number of LED lamps is further dependent on power factor result when connected to dimmer. |
| | Dimmable LED drivers | 200W @ 230V 100W @ 120V | Maximum permitted number of drivers is 200W divided by driver nameplate power rating. |
| | Incandescent lighting, HV Halogen lamps | 400W @ 230V 200W @ 120V | |
| | Low voltage halogen lighting with electronic transformers | 200W @ 220V 100W @ 110V | |

4. TouchLink to a Zigbee Remote

Step 2: Bring the remote or touch panel within 10cm of the lighting device.

Step 3: Set the remote or touch panel into Touchlink commissioning, please refer to corresponding remote or touch panel manual to learn how.

Step 4: There shall be indication on the remote for successful link and connected light will flash twice.

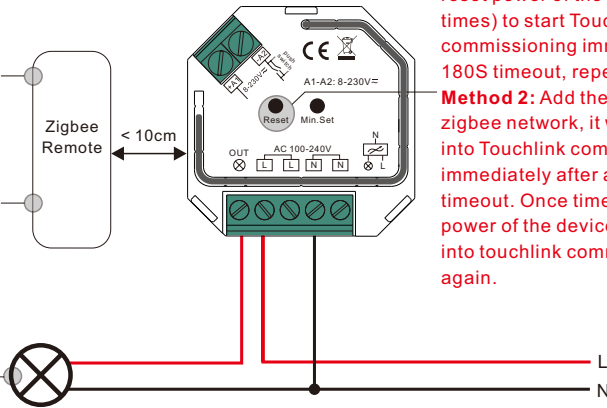

Step 1: Method 1: Short press "Reset" button 4 times (or reset power of the device 4 times) to start Touchlink commissioning immediately, 180S timeout, repeat this step.
Method 2: Add the device to a zigbee network, it will be set into Touchlink commissioning immediately after added, 180S timeout. Once timeout, reset power of the device to set it into touchlink commissioning again.

Note: 1) Directly TouchLink (both not added to a ZigBee network), each device can link with 1 remote.
 2) TouchLink after both added to a ZigBee network, each device can link with max. 30 remotes.
 3) To control by both gateway & remote, add remote and device to network first then TouchLink.
 4) After TouchLink, the device can be controlled by the linked remotes.

5. Removed from a Zigbee Network through Coordinator or Hub Interface

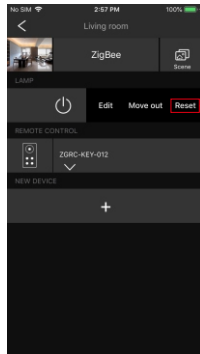

From your ZigBee controller or hub interface, choose to delete or reset the lighting device as instructed. The connected light blinks 3 times to indicate successful reset.

6. Factory Reset Manually

Note: All configuration parameters will be reset after the device is reset or removed from the network.

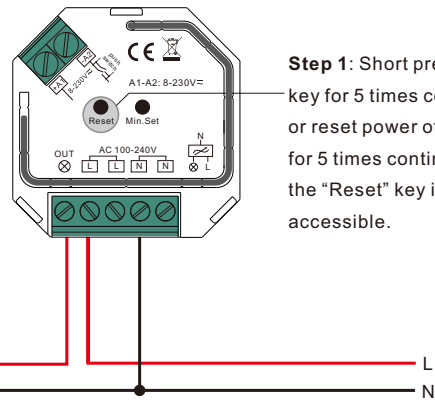

Step 1: Short press "Reset." key for 5 times continuously or reset power of the device for 5 times continuously if the "Reset" key is not accessible.

Step 2: Connected light will blink 3 times to indicate successful reset.

7. Factory Reset through a Zigbee Remote (Touch Reset)

Note: Make sure the device already added to a network, the remote added to the same one or not added to any network.

Step 2: Bring the remote or touch panel within 10cm of the lighting device.

Step 3: Set the remote or touch panel into Touch Reset procedure to reset the device, please refer to corresponding remote or touch panel manual to learn how.

Step 4: There shall be indication on the remote and connected light flashes 3 times for successful reset.

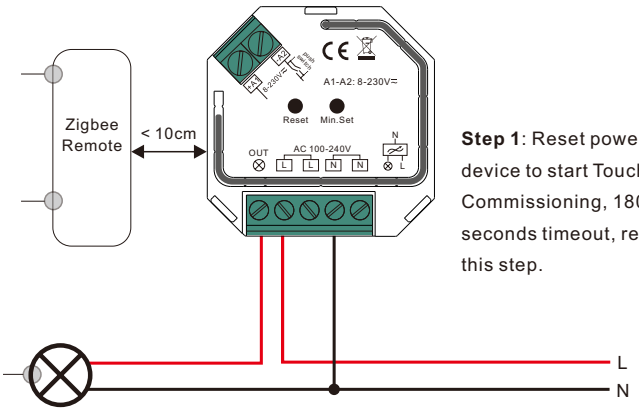

Step 1: Reset power of the device to start TouchLink Commissioning, 180 seconds timeout, repeat this step.

8. Find and Bind Mode

Note: Make sure the device and remote already added to the same zigbee network.

Step 2: Set the remote or touch panel (target node) into find and bind mode, and enable it to find and bind initiator, please refer to corresponding remote or touch panel manual.

Step 3: There shall be indication on the remote or touch panel that it bind the device successfully and can control it then.

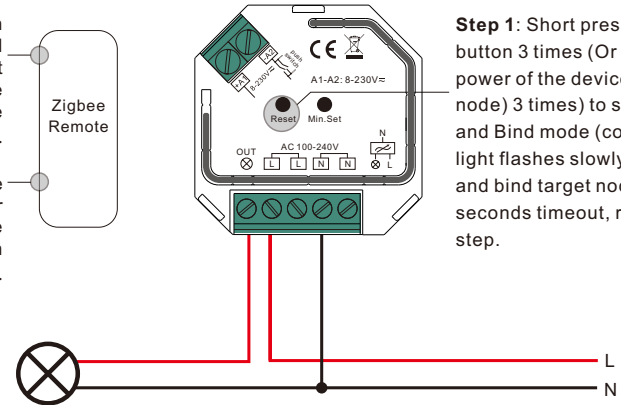

Step 1: Short press "Reset." button 3 times (Or reset power of the device (initiator node) 3 times) to start Find and Bind mode (connected light flashes slowly) to find and bind target node, 180 seconds timeout, repeat this step.

9. Learning to a Zigbee Green Power Switch

Step 2: Set the green power switch into Learning mode, please refer to its manual.

Step 3: Connected light will flash twice to indicate successful learning. Then the switch can control the device.

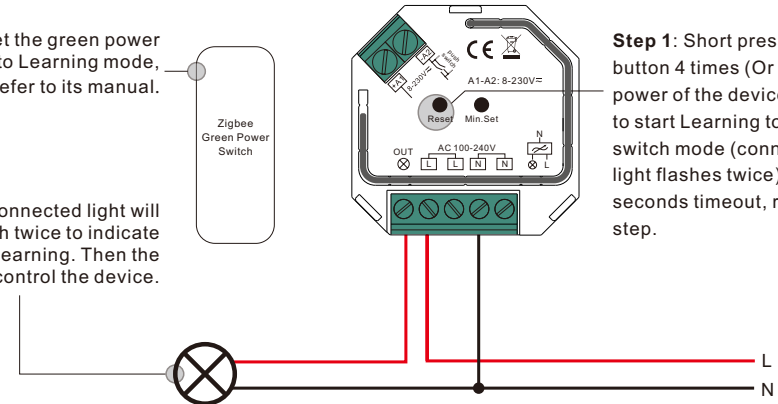

Step 1: Short press "Reset." button 4 times (Or reset power of the device 4 times) to start Learning to GP switch mode (connected light flashes twice), 180 seconds timeout, repeat this step.

Note: Each device can learn to max. 20 zigbee green power switches.

10. Delete Learning to a Zigbee Green Power Switch

Step 2: Set the paired green power switch into Learning mode, please refer to its manual.

Step 3: Connected light will flash 4 times to indicate successful deleting.

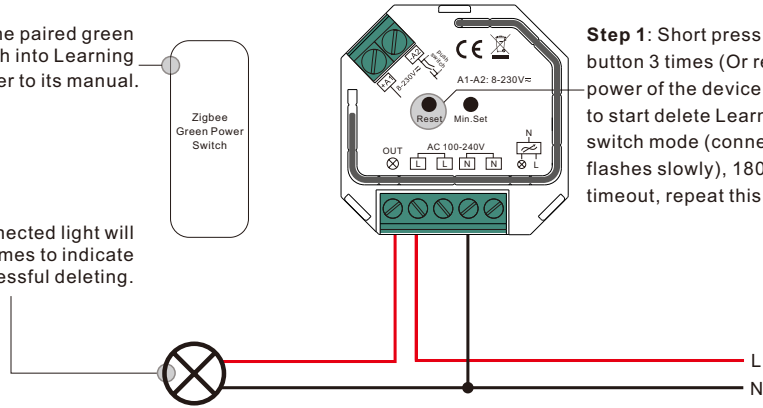

Step 1: Short press "Reset." button 3 times (Or reset power of the device 3 times) to start delete Learning to GP switch mode (connected light flashes slowly), 180 seconds timeout, repeat this step.

11. Setup a Zigbee Network & Add Other Devices to the Network (No Coordinator Required)

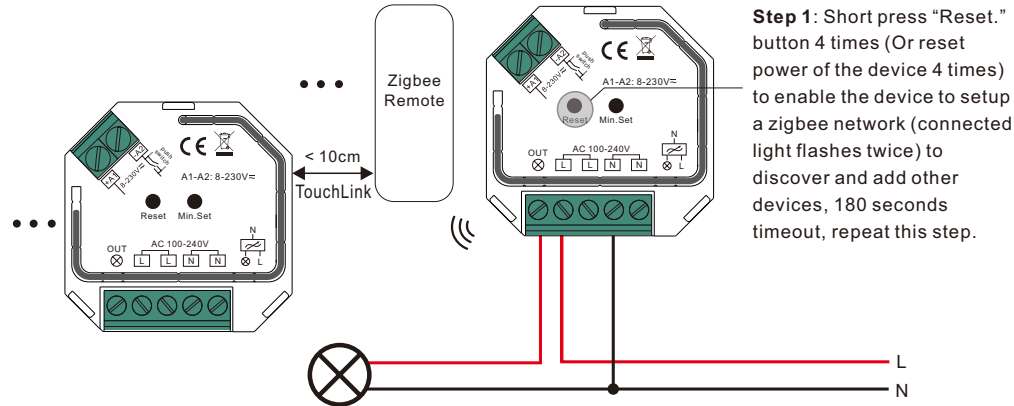

Step 1: Short press "Reset." button 4 times (Or reset power of the device 4 times) to enable the device to setup a zigbee network (connected light flashes twice) to discover and add other devices, 180 seconds timeout, repeat this step.

Step 2: Set another device or remote or touch panel into network pairing mode and pair to the network, refer to their manuals.

Step 3: Pair more devices and remotes to the network as you would like, refer to their manuals.

Step 4: Bind the added devices and remotes through Touchlink so that the devices can be controlled by the remotes, refer to their manuals.

Note: 1) Each added device can link and be controlled by max. 30 added remotes.

2) Each added remote can link and control max. 30 added devices.

12. OTA

The device supports firmware updating through OTA, and will acquire new firmware from zigbee controller or hub every 10 minutes automatically.

13. Setting minimum brightness:

Adjust brightness to a desired level from zigbee hub or controller interface or a remote, then press and hold down "Min. Set" key until connected light flashes, the minimum dimming level is set successfully, then the connected load can only be dimmable between this minimum brightness and 100% brightness.

The dimming range of this dimmer is 1%-100%, but some load types may flicker when dimmed to 1%, thus a minimum brightness shall be set higher than 1% to avoid flickering during dimming process.

14. Delete the minimum brightness:

Adjust the brightness to 100% from zigbee hub or controller interface or a remote, then press and hold down the "Min. Set" key on the dimmer until connected light flashes, which means minimum brightness is deleted successfully.

15. Set Startup Brightness

Step 1: adjust the brightness of connected load to a desired level between 1%-50%.

Step 2: double click "Min. set" key to set the brightness adjusted in step 1 as startup brightness, then the load will first go to startup brightness when turned on every time, then drop down to the brightness before last time turned off.

Note: startup brightness setting function is to avoid the phenomenon that some dimmable LED drivers can not be turned on after turned off at a very low brightness level. Once setting a startup brightness, if the startup brightness is higher than the brightness before turned off, the driver will first go to the startup brightness after turned on then drop down to the level before turned off. If the startup brightness is lower than the brightness before turned off, the driver will directly go to the brightness before turned off.

16. Delete Startup Brightness

Step 1: adjust the brightness of connected load to 0%.

Step 2: double click "Min. set" key to delete the previously set startup brightness.

17. Controlled by a push switch:

Once connected with a push switch, click the push switch to switch ON/OFF, press and hold down it to increase/decrease light intensity.

Wiring diagram

Notes for the diagrams:

L - terminal for live lead

N - terminal for neutral lead

Out - output terminal of the dimmer (controlling connected light source)

+A1 - terminal for push switch

-A2 - terminal for grounding to the switch connected to the dimmer

1) With Single Push Switch

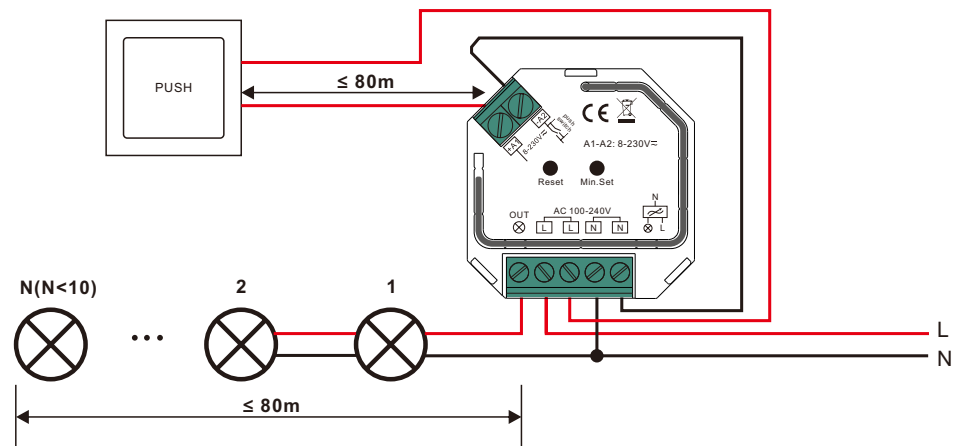

Note:

1) The maximum allowed number of parallel connected drivers or luminaries shall be less than 10, otherwise

the dimmer may be damaged due to the high inrush current at the moment of starting.

- 2) The maximum allowed cable length from the dimmer to connected drivers or luminaries shall not be longer than 80 meters.
- 3) The maximum allowed cable length from the push switches to the dimmer shall not be longer than 80 meters.

2) With Multiple Push Switches for Multiple Control Points

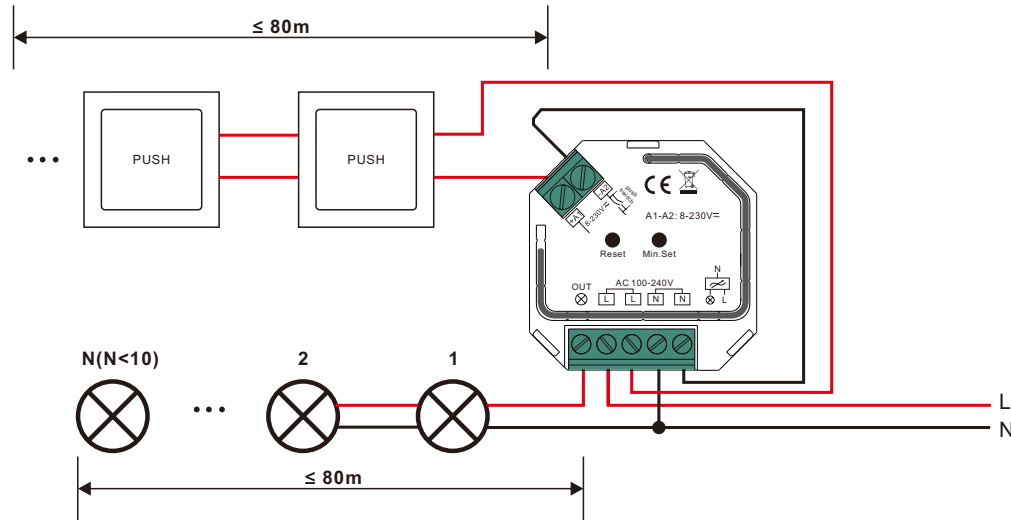

Note:

- 1) The maximum allowed number of parallel connected drivers or luminaries shall be less than 10, otherwise the dimmer may be damaged due to the high inrush current at the moment of starting.
- 2) The maximum allowed cable length from the dimmer to connected drivers or luminaries shall not be longer than 80 meters.
- 3) The maximum allowed cable length from the push switches to the dimmer shall not be longer than 80 meters.

This phase dimmer adopts leading edge dimming (forward phase control) or trailing edge dimming (reverse phase control), two versions are available for choosing, default factory setting is trailing edge, leading edge version available upon request. Please make sure the connected loads support the control type you choose. Please refer to the user manual of the load or consult the supplier of the load.

Product Dimension

